

Les volets bois à lames verticales Ferrage en fourniture

Tracé des pentures.....	page 2
Fixation des pentures pour volets simples.....	page 3
- avec vis à bois sans contre penture.....	page 3
- avec boulons sans contre penture.....	page 3
- avec boulons avec contre pentures.....	page 3
Fixation des pentures pour volets repliables.....	page 5
- avec vis à bois sans contre penture.....	page 5
- avec boulons sans contre penture.....	page 5
- avec boulons avec contre pentures.....	page 6
Mise en place des butées.....	page 7
Pose des crochets de rappel pour volets repliables.....	page 7

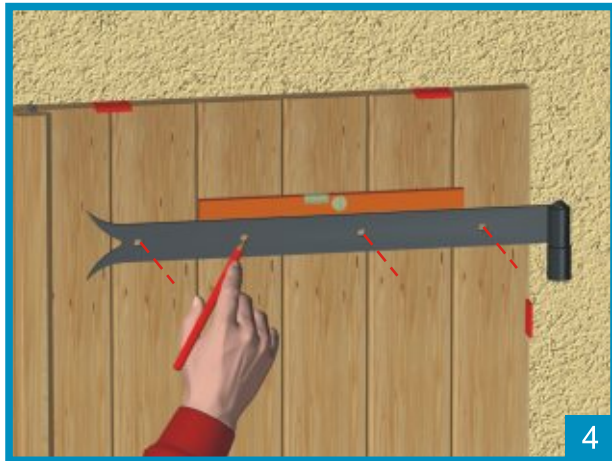

Tracé des pentures

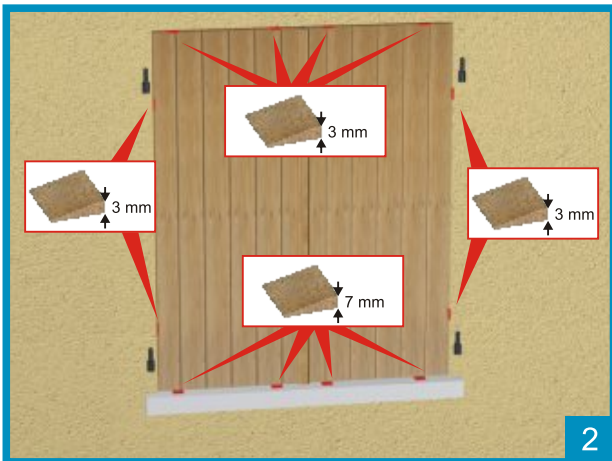
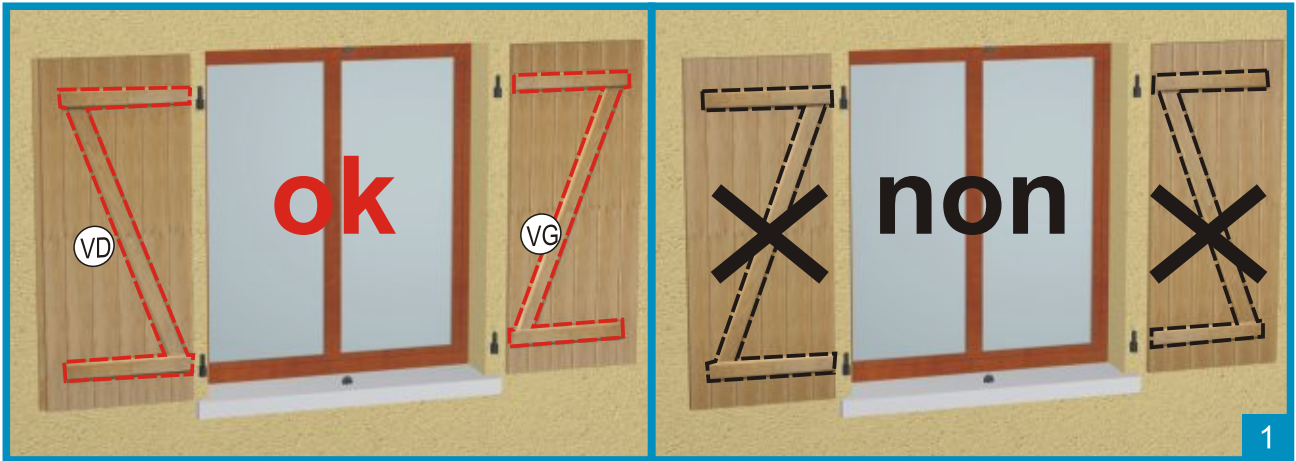

Fixation des pentures pour volets simples

Avec vis à bois sans contre-penture

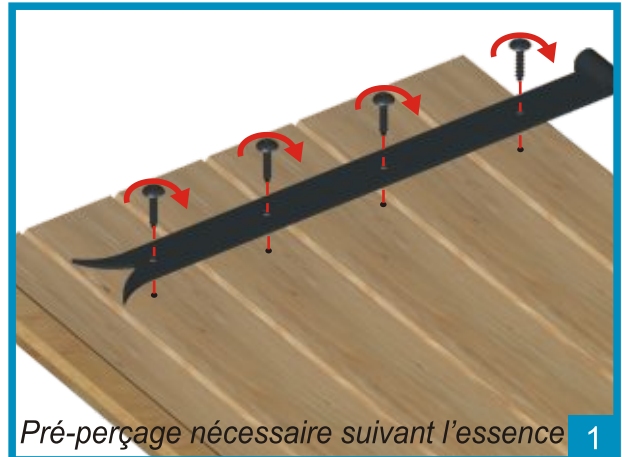

Avec boulons sans contre-penture

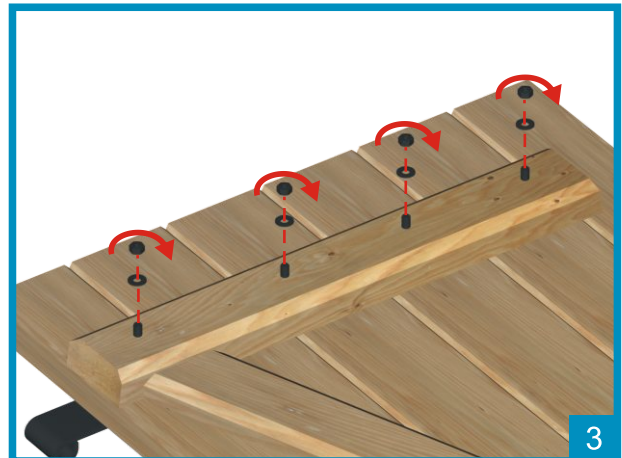
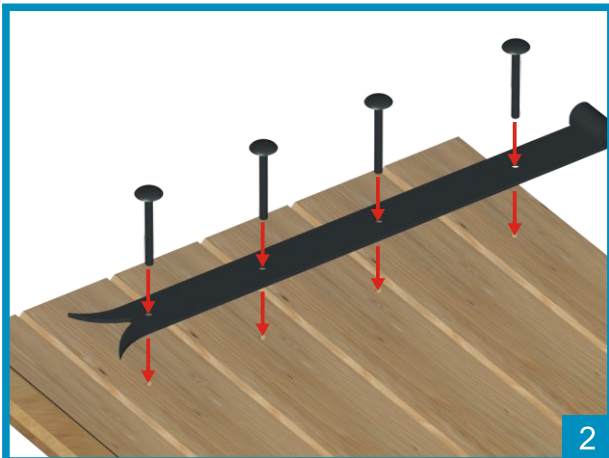
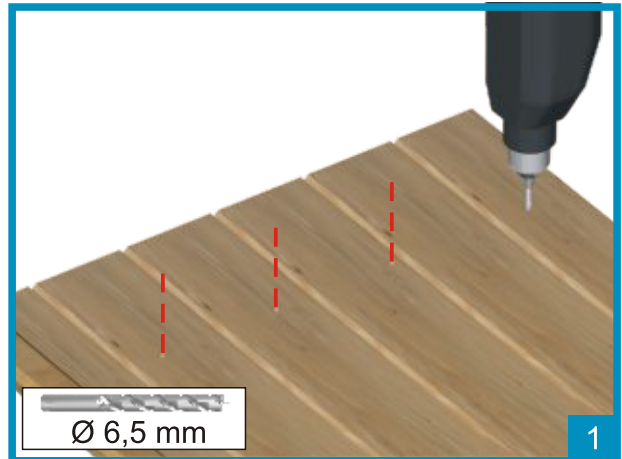

Avec boulons avec contre-pentures

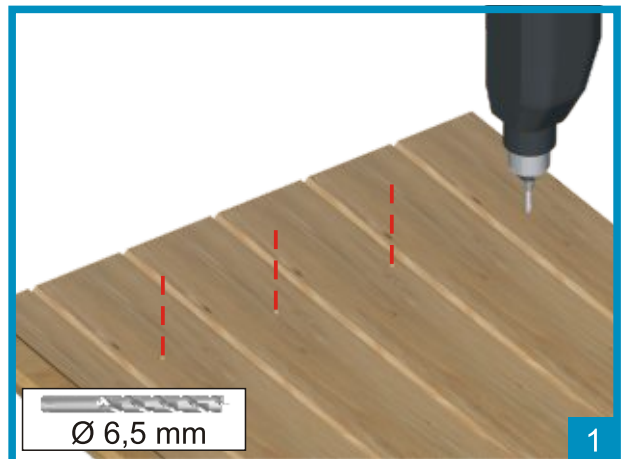

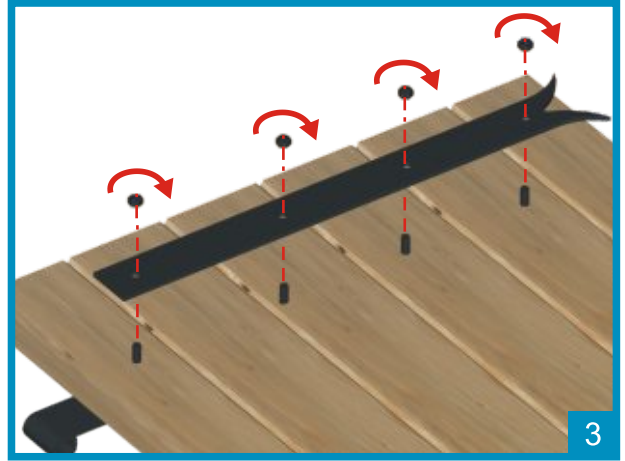
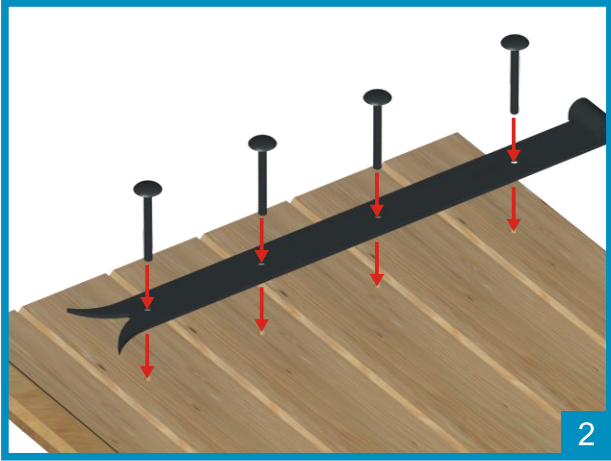

Fixation des pentures pour volets repliables

Avec vis à bois sans contre-penture

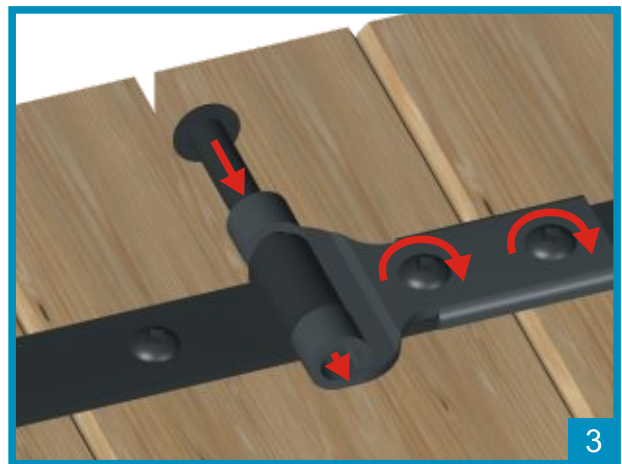
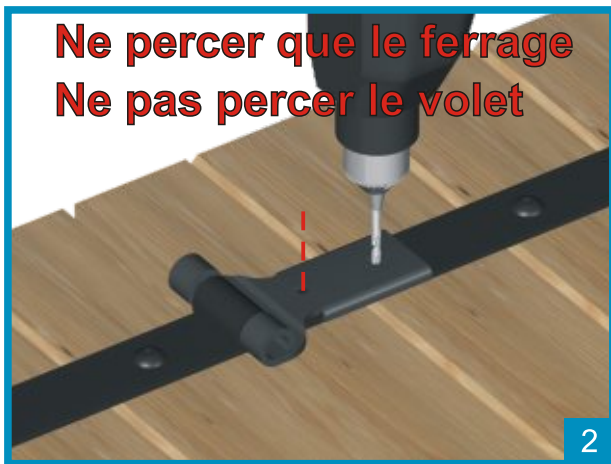
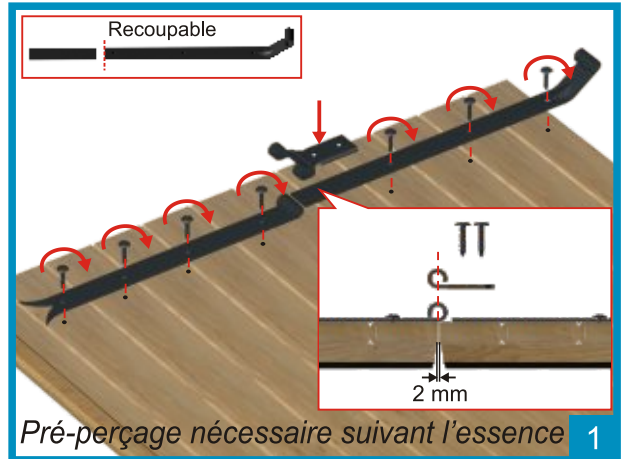

Avec boulons sans contre-penture

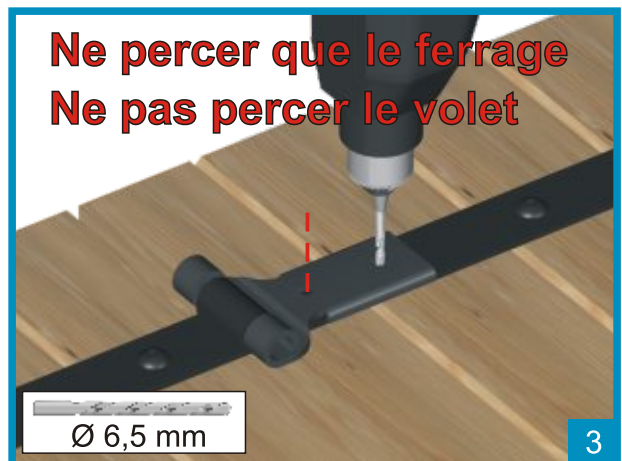
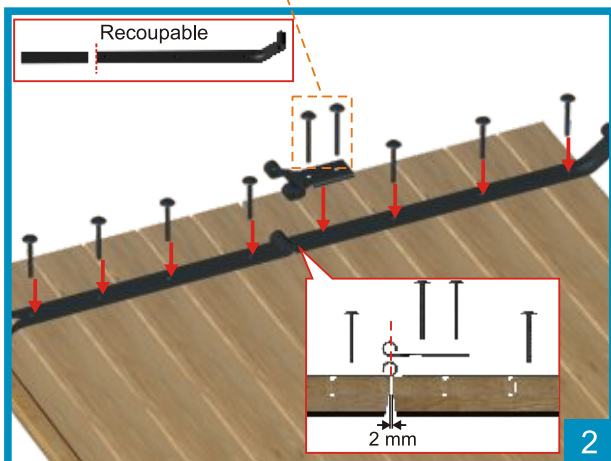
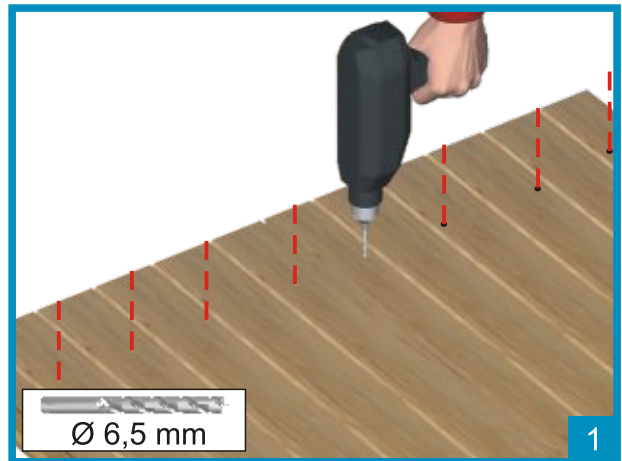
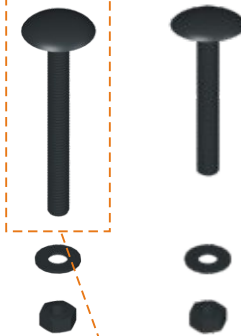

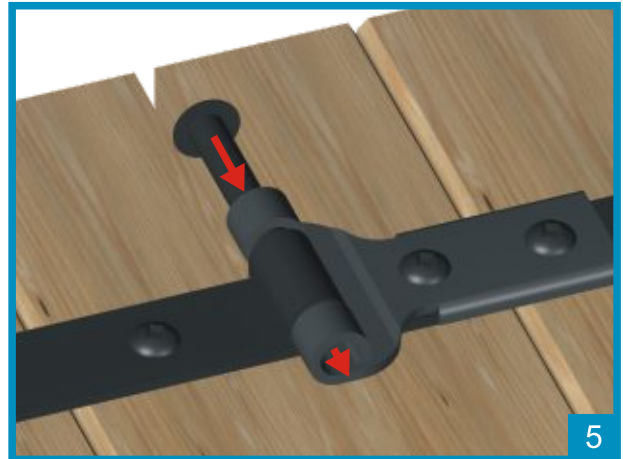
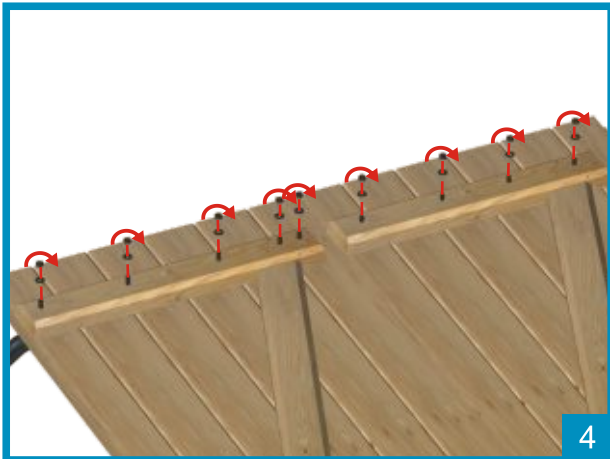

Avec boulons avec contre pentures

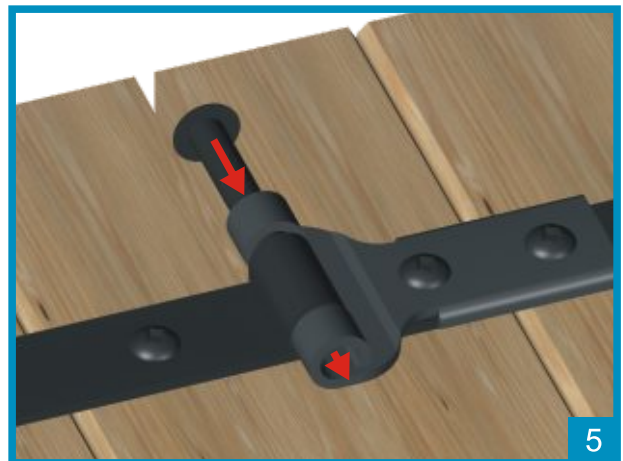
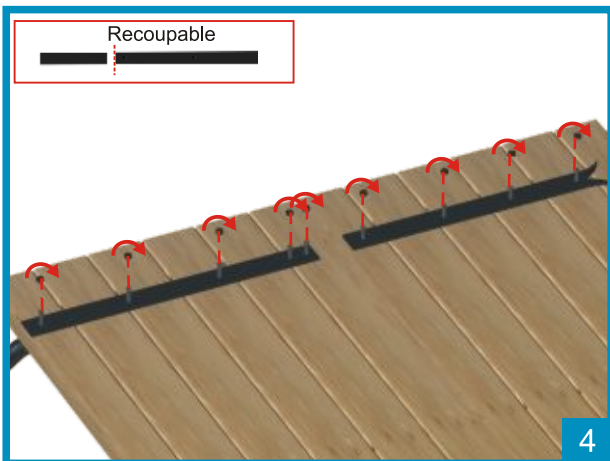
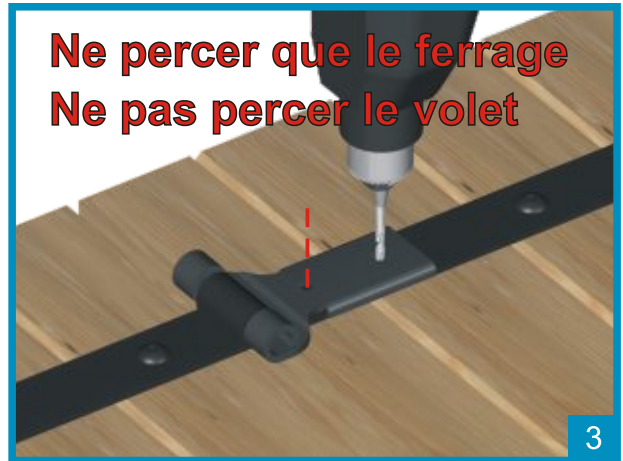
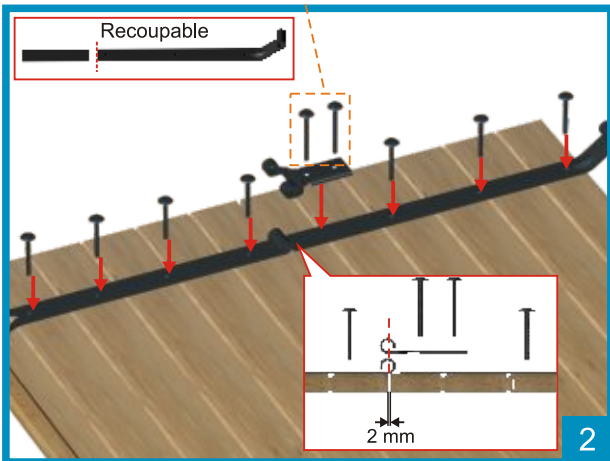
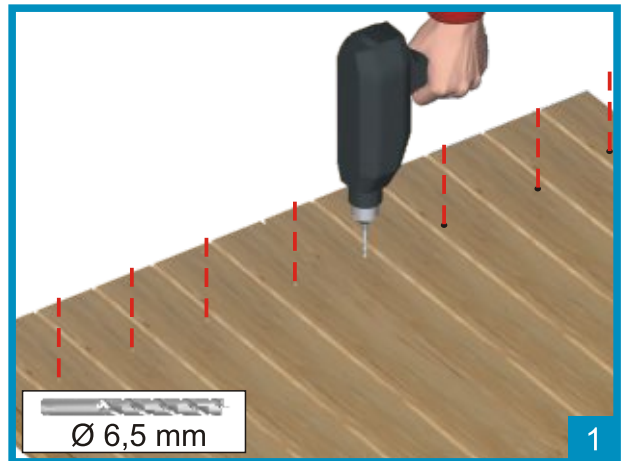
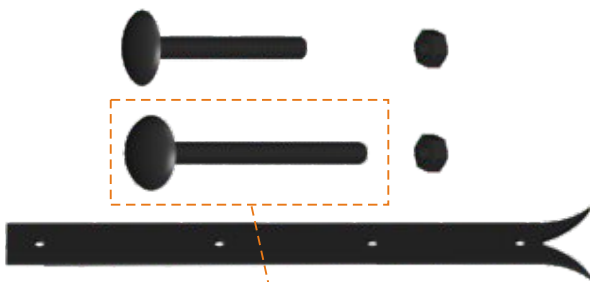

Mise en place des butées

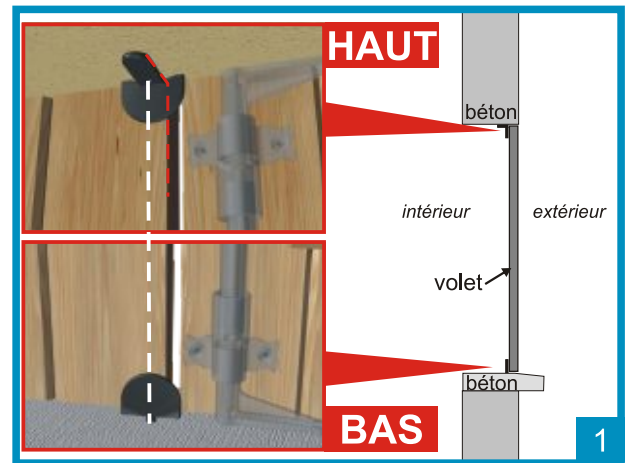

Pose des crochets de rappel pour volets repliables

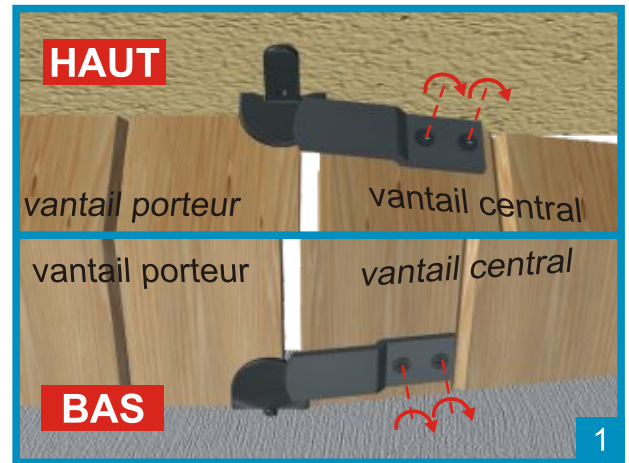
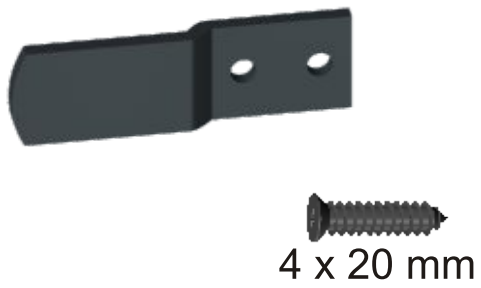

Cas d'un 2 vantaux à gauche